

**TRANSPARENT ENERGY SYSTEMS PVT. LTD.**

**WELCOMES**

**All Delegates**

**in**

**Energy Management Workshop,  
Sail (Salem).**



# The company

- Incorporated on 16<sup>th</sup> April, 1986 as Vapor Energy Machines Pvt. Ltd.
- Renamed on 18<sup>th</sup> December 1995 as Transparent Energy Systems Pvt. Ltd..
- Technology leaders in business groups
- Resource conservation through energy efficiency
- Patented products & services
- Holder of S & U stamps from ASME and R stamp from NB

# Business groups



1	Waste Heat Recovery Systems	<a href="http://www.heatrecovery-system.com">www.heatrecovery-system.com</a>
2	Waste Heat driven Power Plants	<a href="http://www.heatrecovery-system.com">www.heatrecovery-system.com</a>
3	Co-generation Systems	<a href="http://www.tesplcogen.com">www.tesplcogen.com</a>
4	Ammonia Absorption Refrigeration Plants	<a href="http://www.tesplaarp.com">www.tesplaarp.com</a>
5	Power Boilers	<a href="http://www.tespowerboilers.com">www.tespowerboilers.com</a>
6	Combustion Turbine Inlet Air Cooling Systems	<a href="http://www.turbineaircooling.com">www.turbineaircooling.com</a>
7	Rankine Cycle Power Plants	<a href="http://www.rankineplant.com">www.rankineplant.com</a>

# Business groups (cont'd)



8	Air Cooled condensers & Coolers	<a href="http://www.tespl.com">www.tespl.com</a>
9	Process Boilers & Heaters	<a href="http://www.tesprocessboilers.com">www.tesprocessboilers.com</a>
10	Biomass Gasification Plants.	<a href="http://www.bmethanation.com">www.bmethanation.com</a>
11	Lithium Bromide Absorption Chillers	<a href="http://www.tespl.com">www.tespl.com</a>
12	Zero Liquid Effluent Discharge Plants	<a href="http://www.zldplants.com">www.zldplants.com</a>
13	Waste Incineration fired Power Plants	<a href="http://www.mswcombustion.com">www.mswcombustion.com</a> ; <a href="http://www.mswuse.com">www.mswuse.com</a>
14	Energy & Water Conservation Consultancy.	<a href="http://www.tespl.com">www.tespl.com</a>

## Business alliances & collaborations



Mattes Engineering GmbH, Germany – *Since 1994*  
Technical collaboration and know-how transfer agreement for  
Ammonia Absorption Refrigeration Plants (AARP)  
[www.mattes-int.com](http://www.mattes-int.com)



LaMont-Kessel GmbH & CO., Germany – *Since 2007*  
Technology licensing and know-how transfer agreement for  
boiler capacities up to 300 TPH.  
[www.lamont-services.com](http://www.lamont-services.com)



Bioenergie Beratung Bornim GmbH, Germany – *Since 2007*  
Technology licensing and know-how transfer agreement for  
wet & dry fermentation of solid, semi solid & liquid  
biomasses, bio-diesel and ethanol production technologies.  
[www.b3-bornim.de](http://www.b3-bornim.de)

## Business alliances & collaborations (cont'd)



Jiangsu Shuangliang Air-conditioning Equipment Co. Ltd.,  
China – *Since 2004*  
Co-operation agreement for application engineering, sales  
and service of LiBr Absorption Chillers.  
[www.shuangliang.com](http://www.shuangliang.com)



Shandong Qingneng Thermal Power Equipment Co., Ltd.,  
China – *Since 2006*  
Co-operation agreement for application engineering, sales  
and service of Steam Turbines with subsidiary of TESPL.  
[www.qnpower.com](http://www.qnpower.com)



The Cool Solutions Company, USA  
Co-operation understanding for wide range of engineering  
services.  
[www.coolsolutionsco.com](http://www.coolsolutionsco.com)

# Waste Heat Recovery Systems and Power Plants

## Sources of waste heat

- Hot waste gases from
  - Steel Melting Furnaces
  - Industrial Furnaces
  - Incinerators
  - Process Waste Gas
  - Cement Plants
  
- Exhaust gas from Gas Turbines
  
- Exhaust gas from Engine Generators
  - Heavy Fuel Oil fired
  - High Speed Diesel fired
  - Natural Gas fired
  
- Jacket Water from Engine Generators

# BFG Fired Boilers



- 100% BFG combustion *without supporting fuel*
- Cyclonic refractory lined furnace
- Balanced Draft
- Wet front design
- Ceramic ferrule protection for front tube sheet
- UV flame sensors
- Vortex type BFG burners
- Pre-Heated Combustion air
- Water Seal On Gas Line
- Continuous modulation with single element drum level control

**Waste Heat Recovery from flue gases of stoves and its utilization in preheating BFG and Combustion air, in Pig Iron manufacturing Plant.**

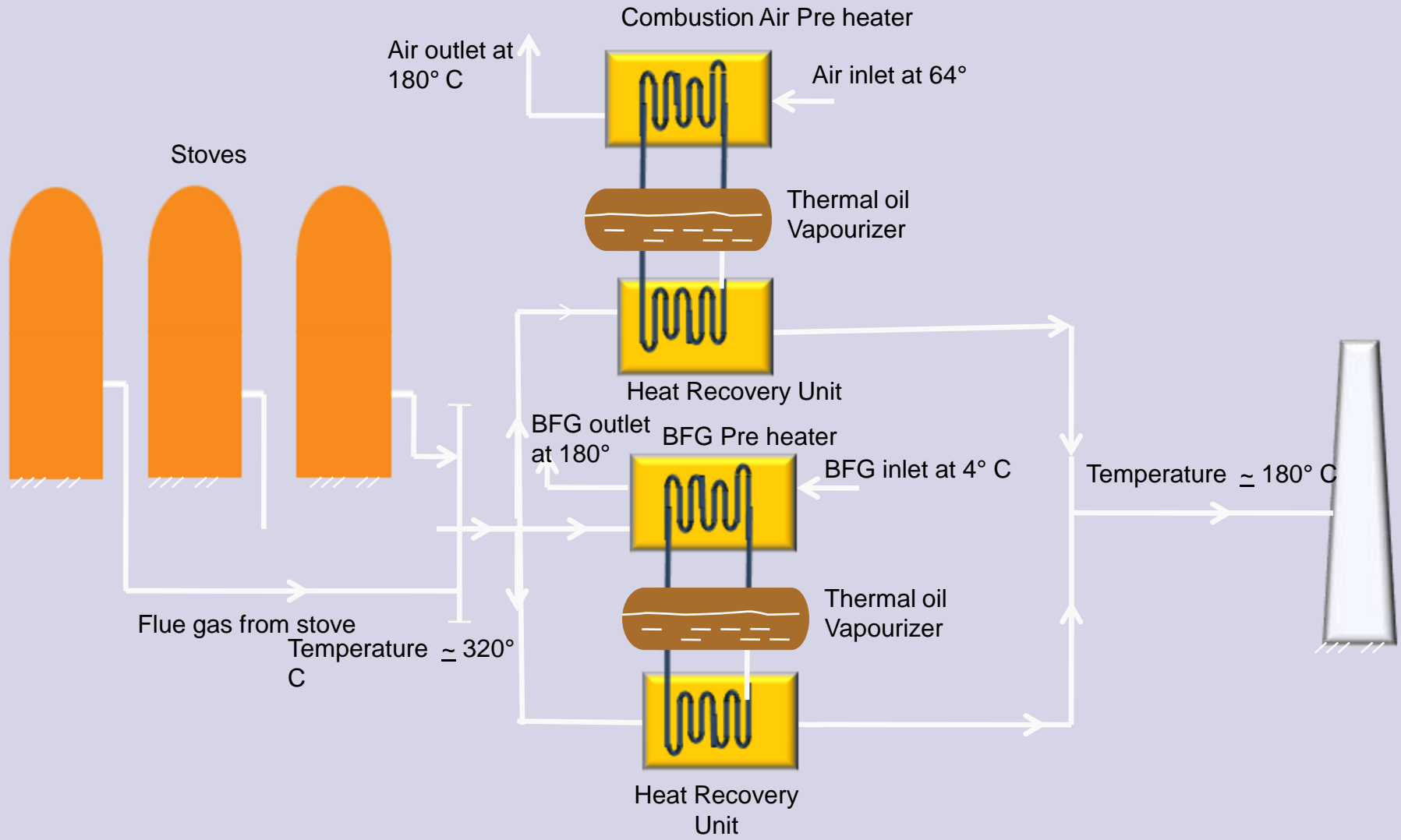

# Vertical Co-Flow design for WHRB



Tubes shown by this colour are in flue gas path



Tubes (headers) shown by this colour are out of flue gas path



Arrows shown by this colour indicate Exhaust gas flow

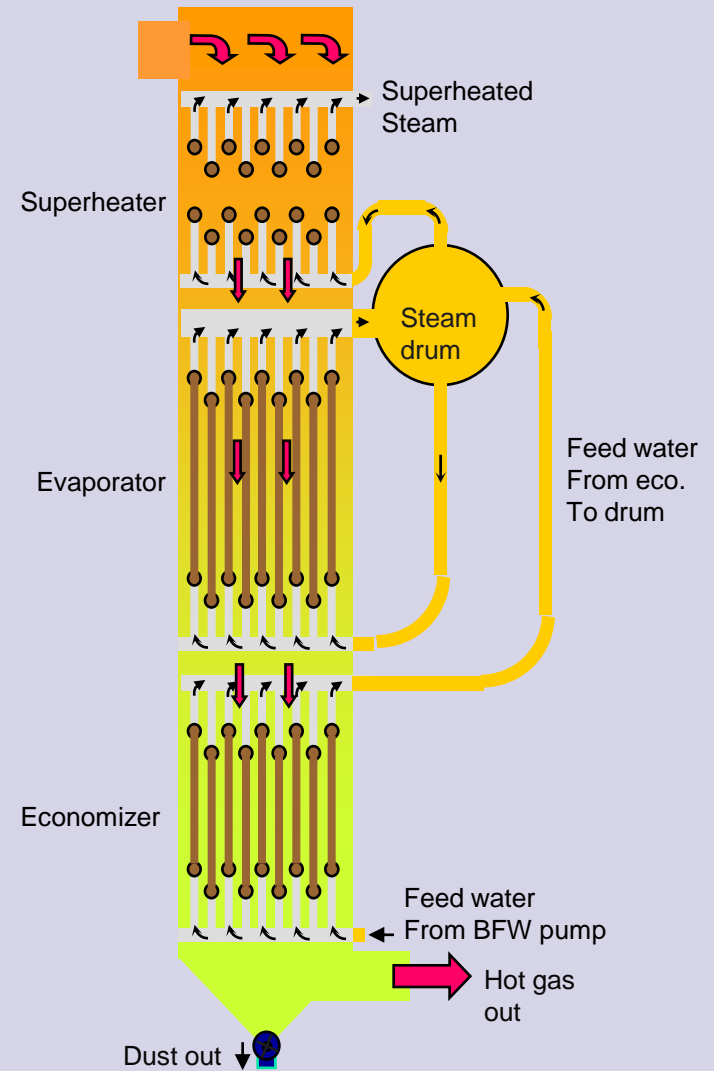

# Waste Heat Recovery Systems (cont'd)



Hot waste gases from Glass Furnace

Exhaust gas from Gas Turbine



# Waste Heat Recovery Systems (cont'd)

Exhaust gas from Engine Generators



WHRB for 3 X 1 MW HSD fired engine



WHRB for 2 X 1 MW gas fired engines



WHRB for 3.8 MW HFO fired engine

# Waste Heat Recovery Systems (cont'd)

Jacket Water heat recovery from Engine Generator set



WHRB on 6.7 MW gas fired engine



# Waste Heat driven Power Plants



## Exhaust gases from

- Cement Plants
- Float Glass Plants
- Gas Turbines
- Engines
- Steel melting furnaces
- Other metallurgical furnaces
- Incinerators
- Process waste gases

# Waste Heat driven Power Plants (cont'd)

- 2.3 MW gross power
- Exhaust gas from Cement Plant
- Plant capacity – 1700 TPD
- Water cooled condensing



# Waste Heat driven Power Plants (cont'd)

- 5 MW gross power in Cement Plant
- Exhaust gas from pre heater only
- Plant capacity – 3000 TPD
- Water cooled condensing



- 4 MW gross power in Cement Plant
- Exhaust gas from clinker cooler only
- Plant capacity – 7500 TPD
- Air cooled condensing

# Waste Heat driven Power Plants (cont'd)



- 13.2 MW gross power
- Exhaust gas from Pre heater & Clinker Cooler both.
- Plant capacity : 3000 TPD X 2 Nos.
- Air cooled condensing  
( Project under execution )

# Co-generation Systems

- Combined generation of

Power

Heat

Refrigeration & Chilling

Evaporation & Drying

- Fuels & Energy Sources

Coal

Biomass / Agro residue

HFO / LDO / HSD / NG

Bio gas

Process waste gas

# Co-generation Systems (cont'd)

FUEL :  
 Biomass, Agrofuels, Coal,  
 Heavy Oil,  
 Natural Gas.

## Steam Turbine based Rankine Cycle Co-generation

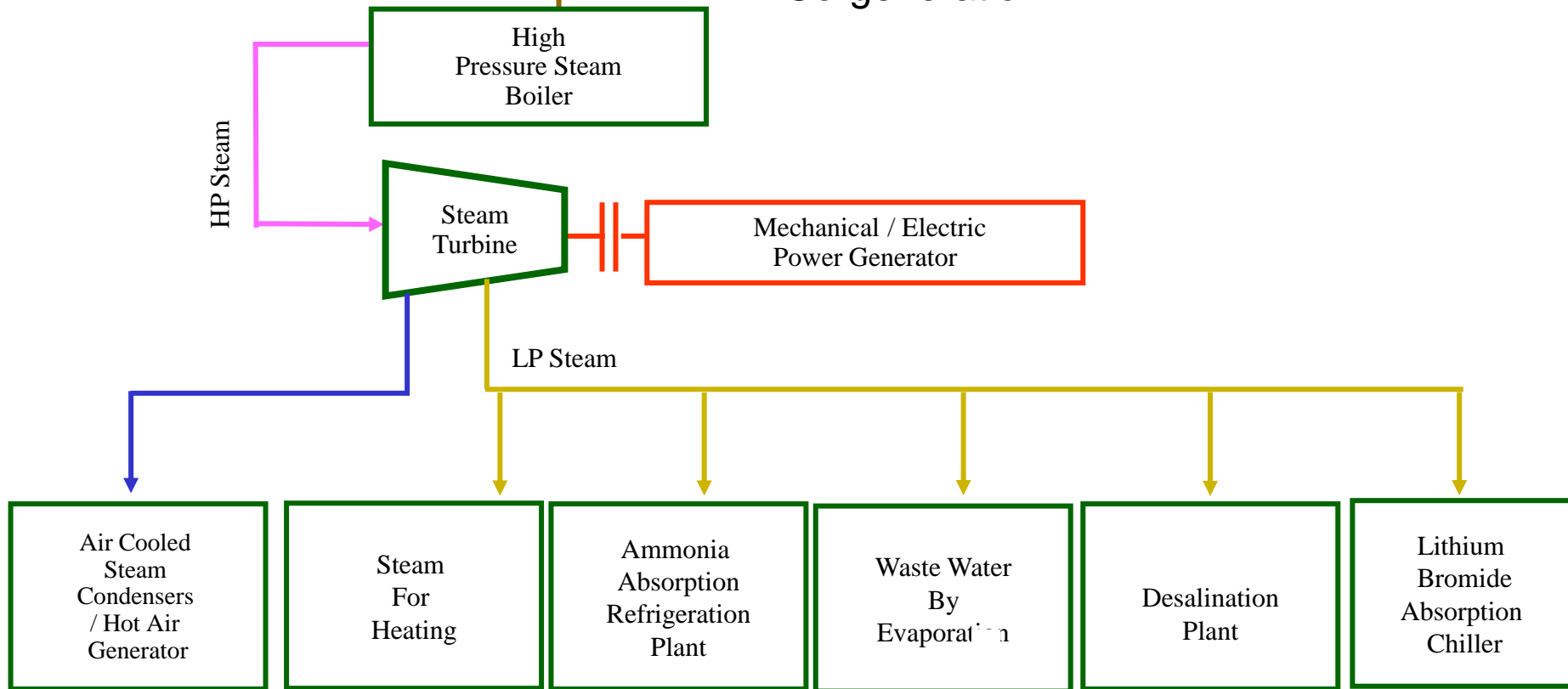

# Co-generation Systems (cont'd)



Engine based Co-generation

Gas Turbine based Co-generation



# Ammonia Absorption Refrigeration Plants

- Technical collaboration and know-how transfer agreement with Mattes Engineering GmbH, Germany

- Operates on low grade energy sources

Steam

Hot Water

Hot Oil

Fuel fired

- Wide operating range

+5 to -60 Deg. C

- Ammonia is an Eco – Friendly refrigerant

- High reliability and low maintenance

- Long life – At least 25 years

# Ammonia Absorption Refrigeration Plants (cont'd)



- Freeze Drying
- Food Refrigeration
- Brine Cooling
- Cold Storage
- Vapor ammonia recovery in chemical processes



- Refineries
- Fertilizer Plants
- Bulk Drug Industries
- Pesticide Plants
- Chemical Plants.



- Dairies
- Ice Plants
- Ice Cream Plants
- Meat Processing
- Fish Processing

# Ammonia Absorption Refrigeration Plants (cont'd)



- Client : CCL Products Ltd.,  
Vijaywada, AP
- Application : Coffee freeze  
drying
- Brine temperature : - 54 Deg. C
- Capacity : 2100 kw

# Power Boilers

- Technology licensing and know-how transfer agreement with LaMont Kessel GmbH & Co., Germany
- Steam Boilers
  - Capacities up to 290 TPH
  - Pressures from 8 to 136 bar
  - Temperatures up to 535 C
- Thermal Oil Heaters / Hot Water Boilers
  - Capacities from 1 MW to 174 MW
- Waste Heat Recovery Boilers
- Fuel suitability
  - Fuel Oils / NG / Coal / Biomass
  - Industrial & Municipal Waste
- Over 20000 designed installations so far by LaMont.



# Power Boilers (cont'd)

Horizontal compact boiler – 100 TPH



Waste Heat Recovery Boiler for  
Kawasaki

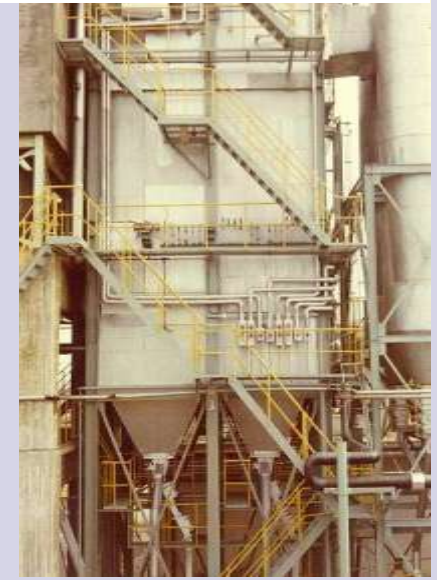

# Zero Liquid Effluent Discharge Plants



- Low grade energy driven Multistage Evaporation Plants

- Can be followed by Spray Drier to make it a Zero Liquid Discharge Plant for effluent.

- High evaporation efficiencies available
  - 3 stage plant - 4.4 kg water / kg steam
  - 5 stage plant - 7 kg water / kg steam
  - 7 stage plant - 10 kg water / kg steam



- Driving source of low grade energy can be,
  - Incinerator exhaust gas
  - Furnace exhaust gas
  - Engine exhaust gas
  - Engine Jacket water

# Waste Incineration fired Power Plants

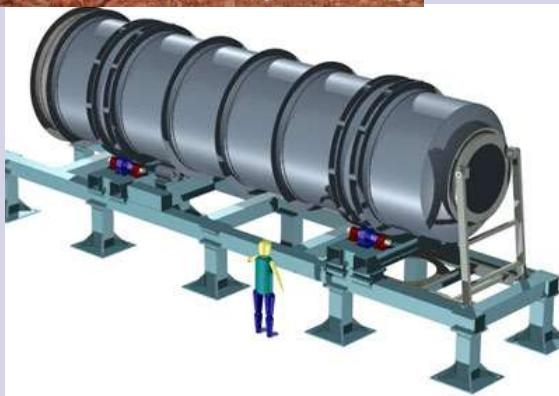

MSW / any other waste incineration for

- Power generation
- Process steam generation
- Process hot water generation

Technology options

- Rotary kiln
- Travelling Grate

Designed to mass incinerate un-segregated waste with supplementary fuel firing

Engineered to meet emission norms of

- MSW rules 2000
- Directive 2000 /76 /EC

# Rankine Cycle Power Plants (cont'd)

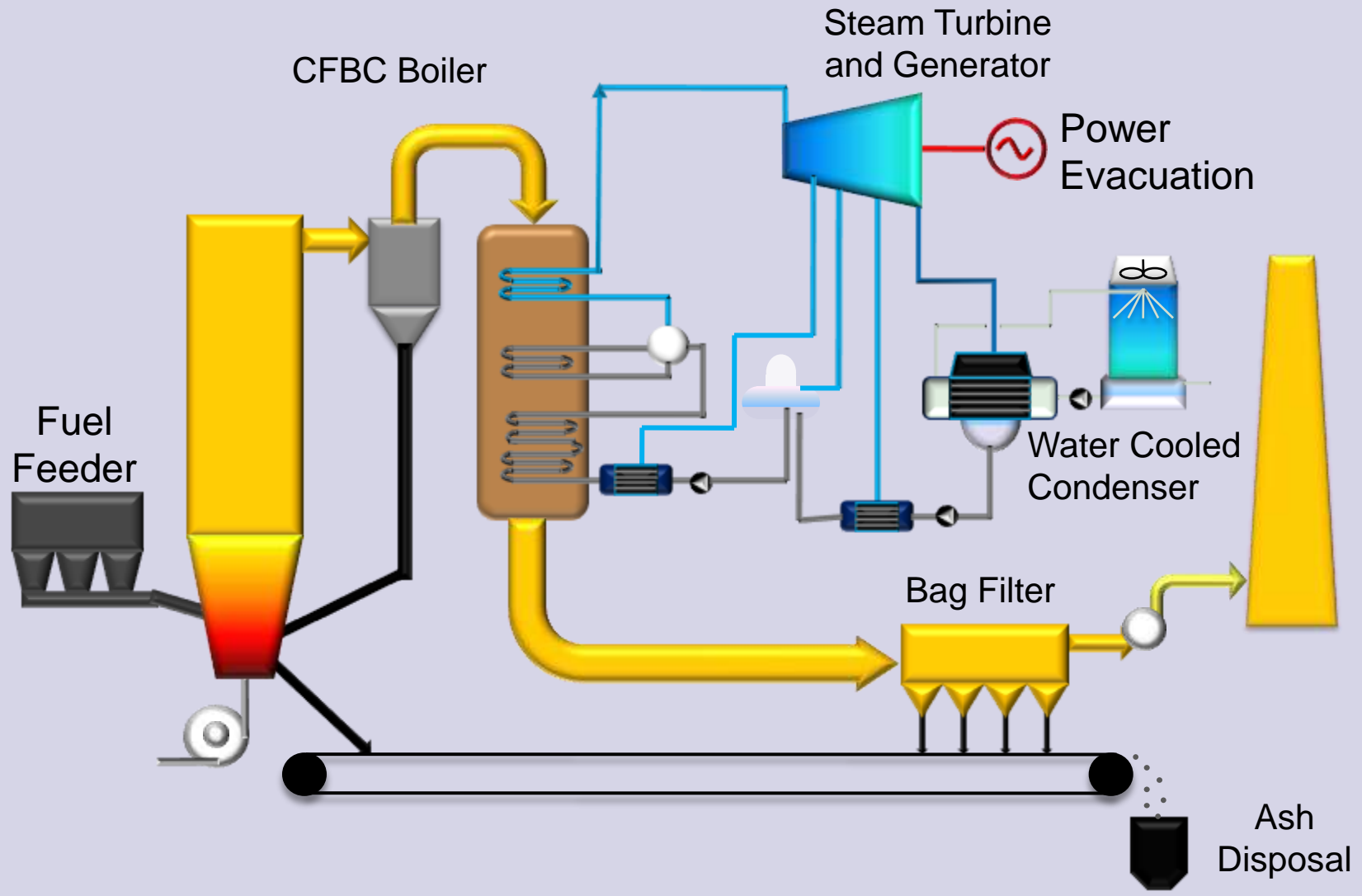

# Biomass Gasification Plants



- Technology licensing & know-how transfer agreement with Bioenergie Beratung Bornim GmbH, Germany.  
<http://www.b3-bornim.de>



- Generation of energy from renewable source i.e. Electricity, Steam, Hot Water, Cooling, Chilling, fuel from bio waste

- Nutrient rich bio fertilizer production as a by product

- Two Stage methanation process

- Earns carbon credits :  $\text{CH}_4$  has 21 times global warming potential than  $\text{CO}_2$



# Biomass Gasification Plants (cont'd)

## Potential biomasses

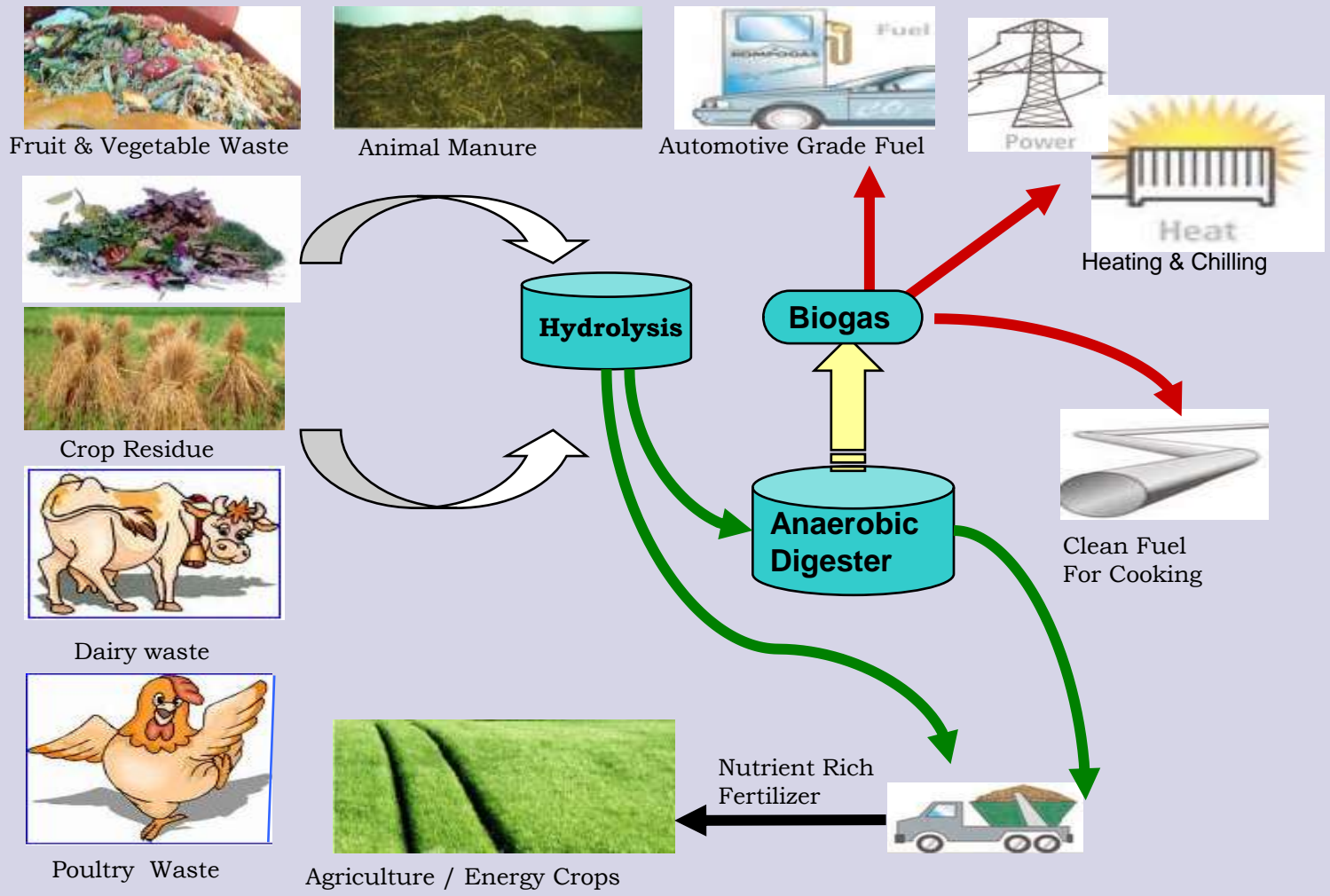

# Energy & Water Conservation Consultancy

- Consultancy in Energy & Water Recycling.
- Integration with process plant.
- Customized & optimal solutions.
- Green field projects as well.

# Industries we serve



Cement	Dairy	Distilleries
Steel	Paper Mill	Refineries
Sugar	Ceramic	Fertilizers
Chemical & process	Food	Pesticides
Pharmaceutical	Edible oil	Breweries
Textile	Automobile	Software Parks
Hotels	Commercial complexes	Solvent Extraction

# Customers

Client Base	Total Customers	500
	Overseas Customers	25
	Waste Heat Recovery	180
	Boilers & Heaters	150
	AARP	25
	Other Products	120

Partial list of domestic clients

Waste Heat Recovery Systems

- Tessitura Monti Ltd.
- Galaxy Sunfractants Ltd.
- Asahi Glass India Ltd.
- Heubach Colour Ltd.

# Customers (cont'd)

Partial list of domestic clients

Waste Heat driven Power Plants

- The KCP Ltd.
- Ultratech Cement Ltd.
- Shree Cement Ltd.
- OPG Metals Pvt. Ltd.
- Saint Gobain Glass India Ltd.

Co-generation systems

- JBF Industries
- Godrej Industries Ltd.
- Warna SSK
- Hero Honda Motors Ltd.

Ammonia Absorption Refrigeration Plant

- Pepsico India Holdings Ltd.
- Asian Paints Ltd.
- Cargil Foods
- Galaxy Surfactants Ltd.

Power Boilers

- SEPCO
- Sumeet Industries Ltd.

# Customers (cont'd)

Partial list of domestic clients

Process Boilers & Heaters

- Raid & Taylor,
- Gharda Chemicals Ltd.
- Alkyl Amines Chemicals Ltd
- Sun Pharmaceutical Industries Ltd.

Lilthium Bromide Absorption Chillers.

- Zee Telefilms Ltd.
- CCL Products India Ltd.
- Jindal Coca

Partial list of overseas clients

Waste Heat Recovery Systems

- Janata Jute Mills, Bangladesh
- Comfort Management, Singapore
- Acidos Minerals, Venezuela

# Customers (cont'd)

Partial list of overseas clients

Co-generation systems	<ul style="list-style-type: none"> <li>▪ JBF RAK LLC, UAE</li> </ul>
Process Boilers & Heaters	<ul style="list-style-type: none"> <li>▪ Pan Century Edible Oils SDN.BHD, Malaysia</li> <li>▪ Skymoon Singapore Pte Ltd., Singapore</li> </ul>
Ammonia Absorption Refrigeration Plant	<ul style="list-style-type: none"> <li>▪ Niro A/S, Denmark</li> <li>▪ University of Stuttgart, Germany</li> <li>▪ Mechanik Centre, Germany</li> <li>▪ Pars Oil, Iran</li> <li>▪ Café de Iguacu, Brazil</li> </ul>
Zero Liquid Effluent Discharge Plants	<ul style="list-style-type: none"> <li>▪ A B Mauri La Nga Fermentation Company , Vietnam</li> </ul>

# Manufacturing establishments



Shirwal works

50 km South of Pune,



Bhosari works

20 km North - West of Pune,

# Authorizations





# CERTIFICATE

The Certification Body for Pressure Equipment  
of TÜV NORD Systems GmbH & Co. KG

certifies that the company

**Transparent Energy Systems Private Limited**  
Transparent Group  
Pune, Maharashtra, India – 411 026  
T-145/146/147, M.I.D.C. Bhosari

has been verified and recognized  
as welding workshop in the product range of

**Pressure Equipment, Heat Exchanger, Waste Heat  
Recovery Boiler**

based on the requirements of the standard

**DIN EN ISO 3834-3 (EN 729-3)**

**Certificate-no.: 07-202-1423 EN 2070/09**

The range of validity and details of the inspection can be seen in our

**Report-no.: 21703209**

The company is using a quality assurance system  
technical equipment, qualified personnel and procedures for joining processes  
to manufacture and testing of welded products

This certificate is valid until

**December 2012**



Exam. 14.12.2008

Certification Body for Pressure Equipment  
of TÜV NORD Systems GmbH & Co. KG  
Notified Body Reg.-No. 0045

TÜV NORD Systems GmbH & Co. KG • Essen Office • Certification Body for Pressure Equipment  
Langemannstr. 20 • 45141 Essen  
Telephone +49 (0)201-625-2720 • Fax +49 (0)201-625-2050 • E-mail: [Abkuesting@tuev-nord.de](mailto:Abkuesting@tuev-nord.de)

WSP-16-05-C-1507-00



# CERTIFICATE

The Certification Body for Pressure Equipment  
of TÜV NORD Systems GmbH & Co. KG

certifies that the company

**Transparent Energy Systems Private Limited**  
Transparent Group  
Pune, Maharashtra, India – 411 026  
T – 145/146/147, M.I.D.C. Bhosari

has been verified and recognized  
as manufacturer of

**Pressure Equipment, Heat Exchanger, Waste Heat Recovery Boiler**

according to the rules of

**AD 2000-Merkblatt HP0**  
inclusive of Directive 97/23/EC annex I, sec. 3.1

**Certificate-no.: 07-202-1423-HP-2070/09**

The range of validity and details of the inspection can be taken from our

**Report-no.: 21703209**

The company has established a product-related quality system  
together with personnel and equipment which assures  
manufacturing and testing corresponding to the technical rules.

This certificate is valid until

**December 2012**



Exam. 14.12.2008

Certification Body for Pressure Equipment  
of TÜV NORD Systems GmbH & Co. KG  
Notified Body Reg.-No. 0045

TÜV NORD Systems GmbH & Co. KG • Essen Office • Certification Body for Pressure Equipment  
Langemannstr. 20 • 45141 Essen  
Telephone +49 (0)201-625-2720 • Fax +49 (0)201-625-2050 • E-mail: [Abkuesting@tuev-nord.de](mailto:Abkuesting@tuev-nord.de)

WSP-16-05-C-1507-00



# THANK YOU



Pushpa Heights, Bibwewadi Corner, PUNE, INDIA

Tel. No. : +91 20 24211347 / 24215665

Fax : +91 20 24212533

Email : [trans@pn2.vsnl.net.in](mailto:trans@pn2.vsnl.net.in), [projectsales@tespl.com](mailto:projectsales@tespl.com)

Website : [www.tespl.com](http://www.tespl.com)